

SPECIFICATION SHEET FOR CO SENSOR TYPE CO/SFA-200

PERFORMANCE CHARACTERISTICS

Nominal Range	0 – 200 ppm
Maximum Overload	Nd
Inboard Filter	To remove acid gases
Expected Operation Life	3 years in air
Output Signal	550 ± 150 nA/ppm
Resolution	0,1 ppm
Temperature Range	- 20 °C to 45 °C
Pressure Range	Atmospheric ± 10%
Pressure Coefficient	No data
T ₉₀ Response Time	< 40 sec
Relative Humidity Range	15 % to 90 % R.H. non-condensing
Typical Baseline Range (pure air, 20°C)	-1 to +1 ppm
Maximum Zero Shift (+20°C to +40°C)	2 ppm
Expected Long Term Output Drift	< 2% signal loss/month
Recommended Load Resistor	10 Ohm
Bias Voltage	Not recommended
Repeatability	< 2 % of signal
Output Linearity	Linear

PHYSICAL CHARACTERISTICS

Weight	~ 32 g
Position Sensitivity	None
Storage Life	Six months in container
Recommended Storage Temperature	5 °C – 20 °C
Warranty Period	12 months from date of dispatch

Standard-Size Outline Dimensions

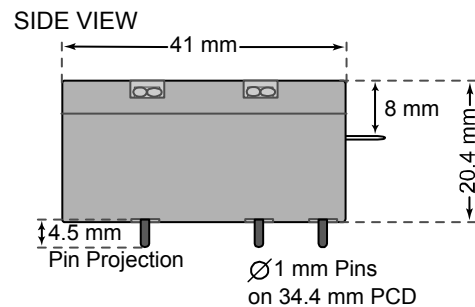
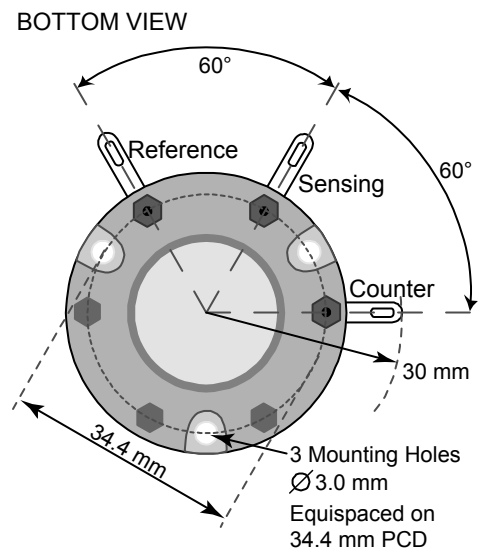

CROSS-SENSITIVITY DATA

Interfering Gas	Cross-Sensitivity (%)
H ₂ S	0
SO ₂	0
NO	0
NO ₂	0
H ₂	< 10

Performance data conditions:
20 °C, 50% RH and 1013 mbar

APPLICATIONS

CO Detection in CO/H₂-Mixtures
Stack/ Flue Gas Monitoring

The data contained in this document is for guidance only. Membrapor AG accepts no liability for any consequential losses, injury or damage resulting from the use of this document or the information contained within it. The data is given for guidance only. Customers should test under their own conditions, to ensure that the sensors are suitable for their own requirements.

REV.: 8/2007

Page 1 of 1

Phone: +41 43 311 72 00
Fax : +41 43 311 72 01
Email: info@membrapor.ch
www.membrapor.ch

MEMBRAPOR AG
Rautistrasse 164
CH-8048 Zürich
Switzerland