

MEMBRAPOR

SPECIFICATION SHEET FOR SO₂ SENSOR TYPE SO2/C-100

PERFORMANCE CHARACTERISTICS

Nominal Range	0 – 100 ppm
Maximum Overload	500 ppm
Expected Operation Life	2 years in air
Output Signal	370 ± 70 nA/ppm
Resolution	0,5 ppm
Temperature Range	- 20 °C to 45 °C
Pressure Range	Atmospheric ± 10%
Pressure Coefficient	No data
T ₉₀ Response Time	< 20 sec
Relative Humidity Range	15 % to 90 % R.H. non-condensing
Typical Baseline Range (pure air, 20°C)	< 0,4 ppm
Maximum Zero Shift (+20°C to +40°C)	N.D.
Long Term Output Drift	< 2% signal loss/month
Recommended Load Resistor	10 Ohm
Bias Voltage	Not required
Repeatability	< 2 % of signal
Output Linearity	Linear

PHYSICAL CHARACTERISTICS

Weight	~ 13 g
Position Sensitivity	None
Storage Life	Six months in container
Recommended Storage Temperature	5 °C – 20 °C
Warranty Period	12 months from date of dispatch

Compact-Size Outline Dimensions

BOTTOM VIEW

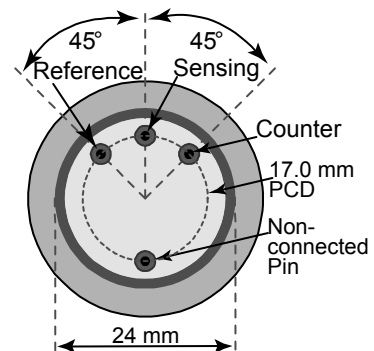

SIDE VIEW

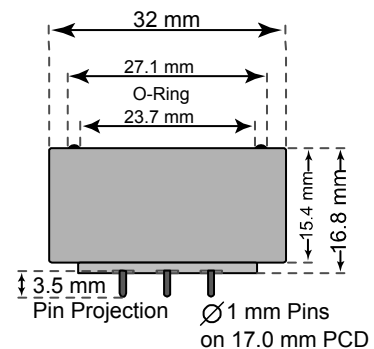

CROSS-SENSITIVITY DATA

Interfering Gas	Concentration	Reading
CO	100 ppm	< 1 ppm
H ₂ S	34 ppm	~ 30 ppm
NO	100 ppm	0 ppm
NO ₂	100 ppm	~ -125 ppm
H ₂	100 ppm	< 1 ppm
Ethylene	100 ppm	0 ppm

Performance data conditions:
20 °C, 50% RH and 1013 mbar

APPLICATIONS

Safety and Environmental Control

The data contained in this document is for guidance only. Membrapor AG accepts no liability for any consequential losses, injury or damage resulting from the use of this document or the information contained within it. The data is given for guidance only. Customers should test under their own conditions, to ensure that the sensors are suitable for their own requirements.

REV.: 6/2006

Page 1 of 1

Phone: +41 43 311 72 00
Fax : +41 43 311 72 01
Email: info@membrapor.ch
www.membrapor.ch

MEMBRAPOR AG
Rautistrasse 164
CH-8048 Zürich
Switzerland